

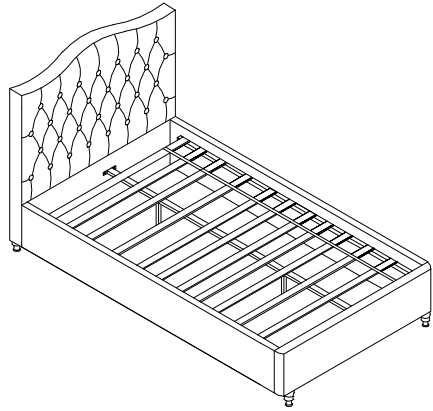









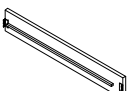





ASSEMBLY INSTRUCTIONS
ITEM NO: BED828-DOUBLE



PARTS LIST

 1 Headboard 1 pc	 2 Side rail 2PCS	 3 Footboard 1PC	 4 Center bar 1PC	 5 Supporting leg 2PCS
 6 Wood leg 4 PCS	 7 Slats 1PC			

HARDWARE LIST

 Bolt A 5/16" * 1-1/2" 16 PCS	 Nut B 5/16" * 12mm 4 PCS	 Flat washer C 16 PCS	 Spring washer D 16 PCS	 E Box wrench 1PC
 F Allen wrench 1PC	 G Driver 24PCS	 H Screw driver 1PC		

Step:1

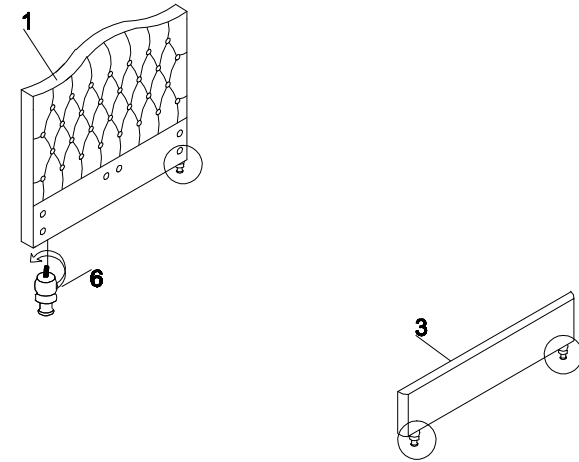

Step:2

