

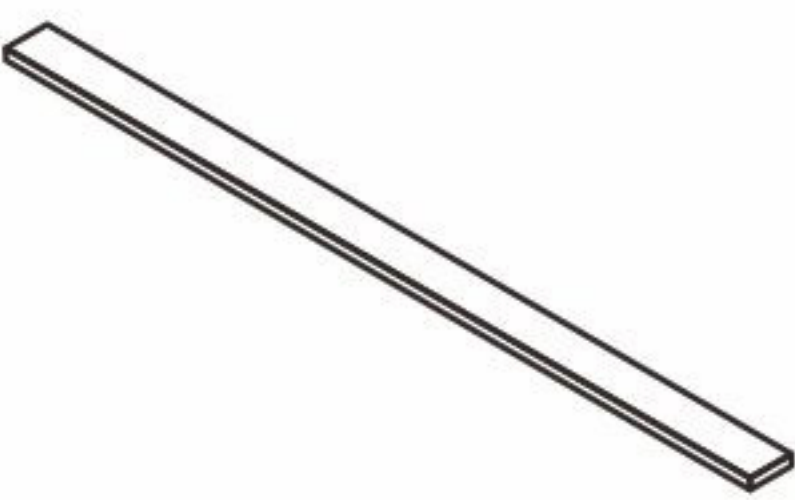

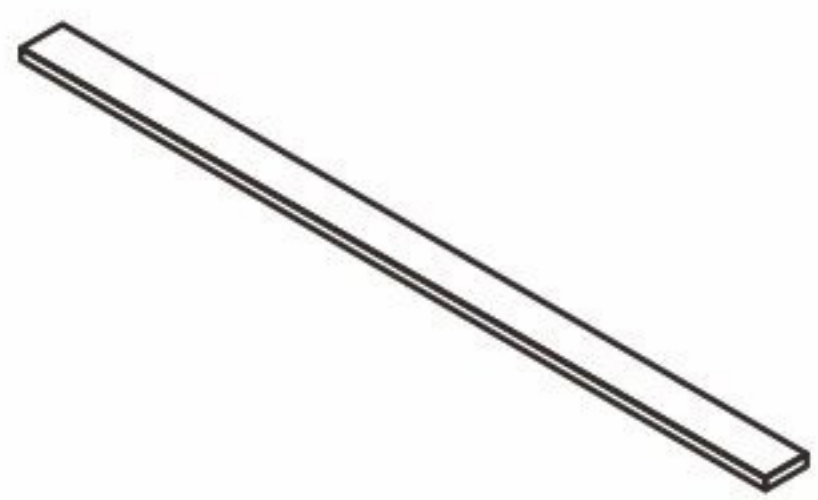

FLATBED ASSEMBLY INSTRUCTIONS

QUEEN & KING

Hardware List:

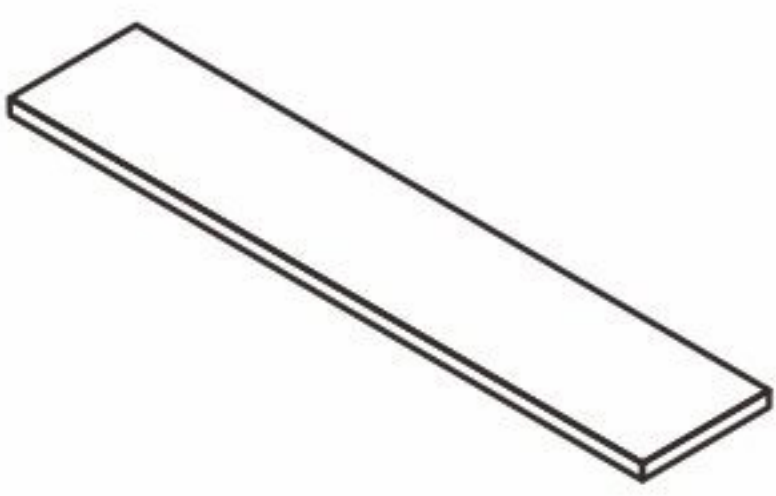
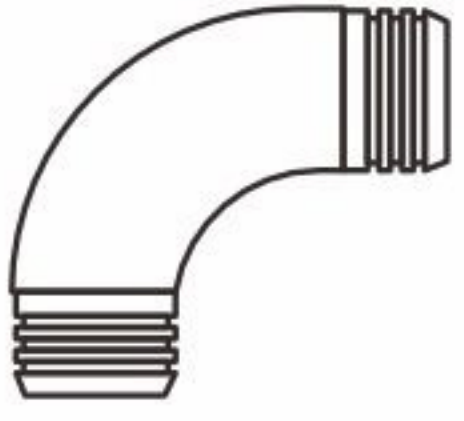
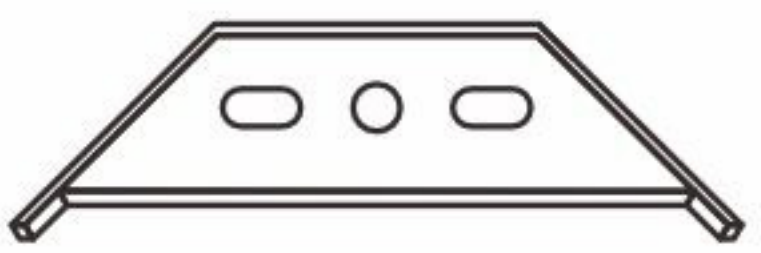
| | | | | |
|--|--|--|---|---|
| 1  Short tube X2 | 2  Long tube X2 | 3  Central tube X2 | 4  Metal leg X4 | 5  Wood slat X13 |
| 6  Plastic corner connector X4 | 7  Metal brackets X4 | 8  Single side plastic cap X26 | 9  Metal leg (I shape) X4 | 10  Screw +nut X 36 |

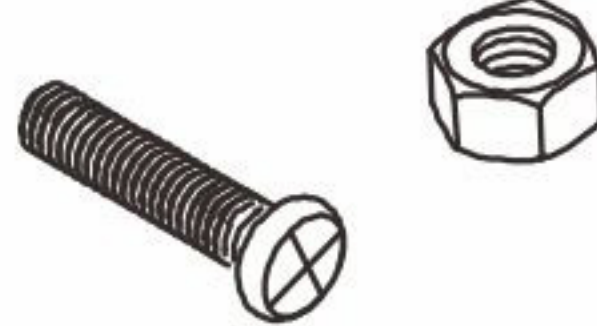
STEP 1

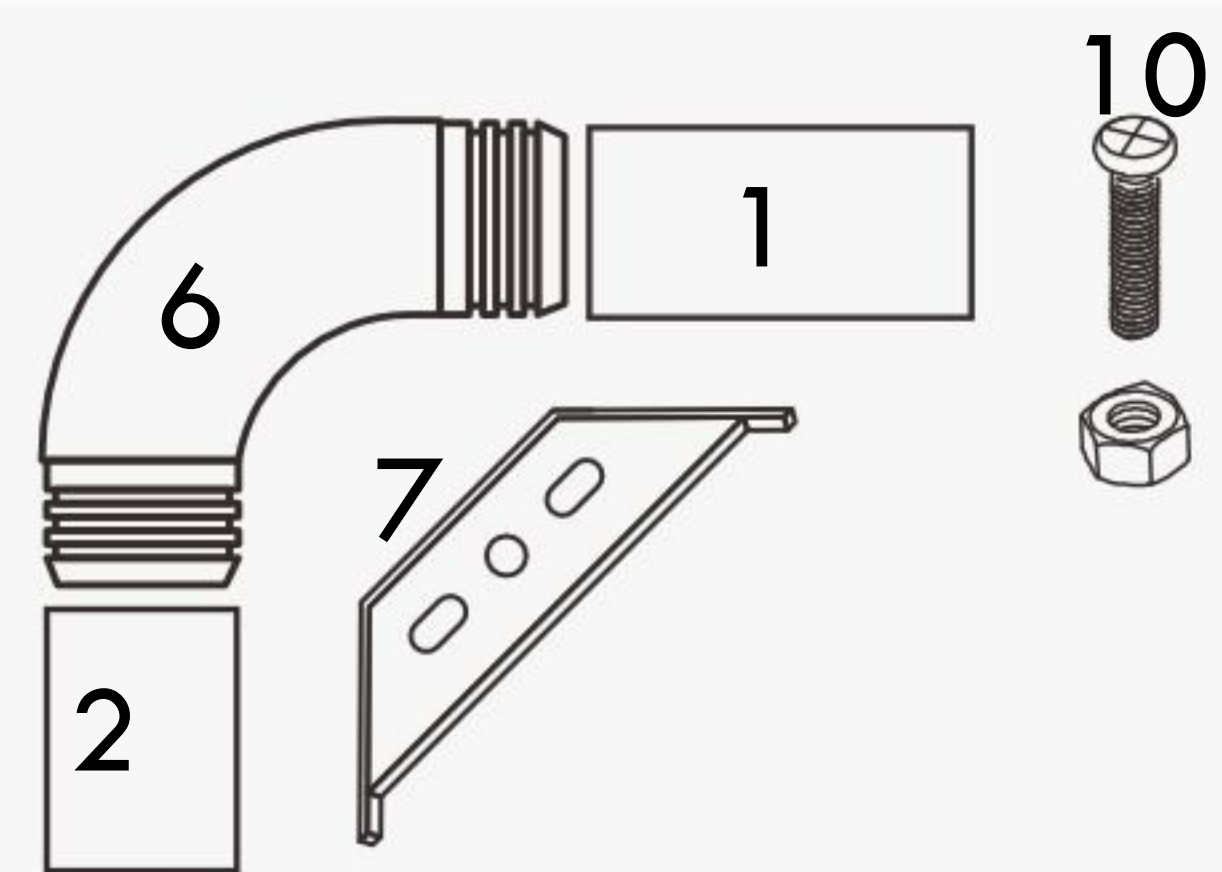

STEP 2

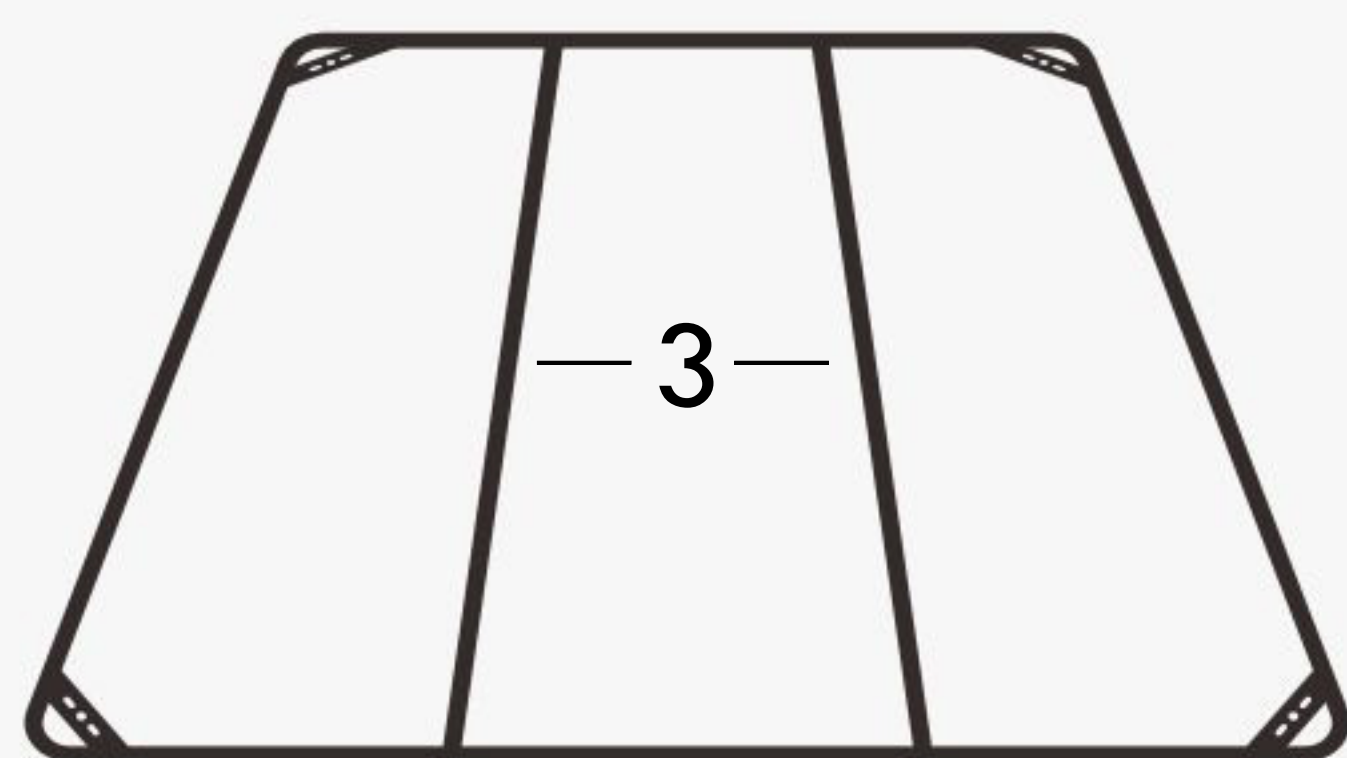

STEP 3

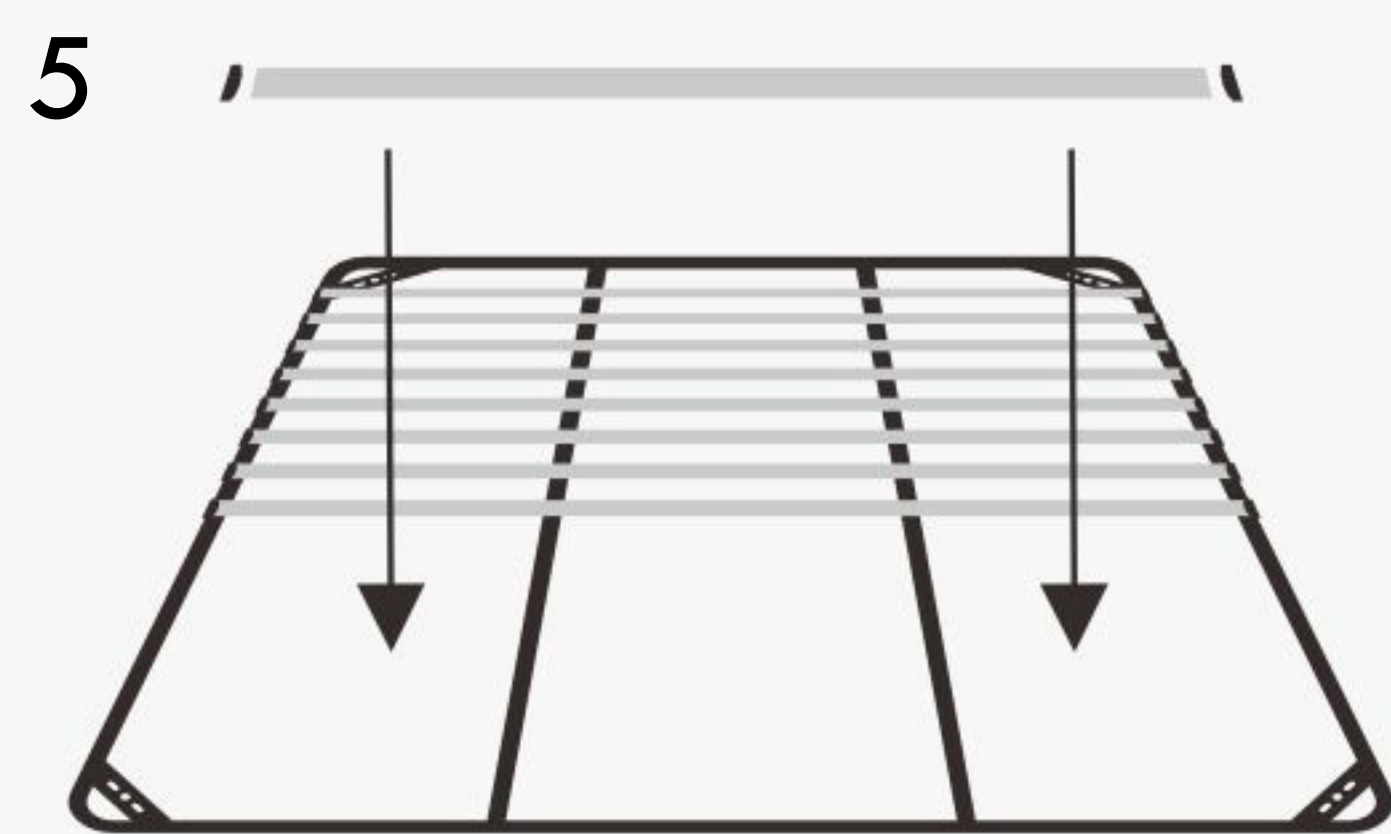

STEP 4

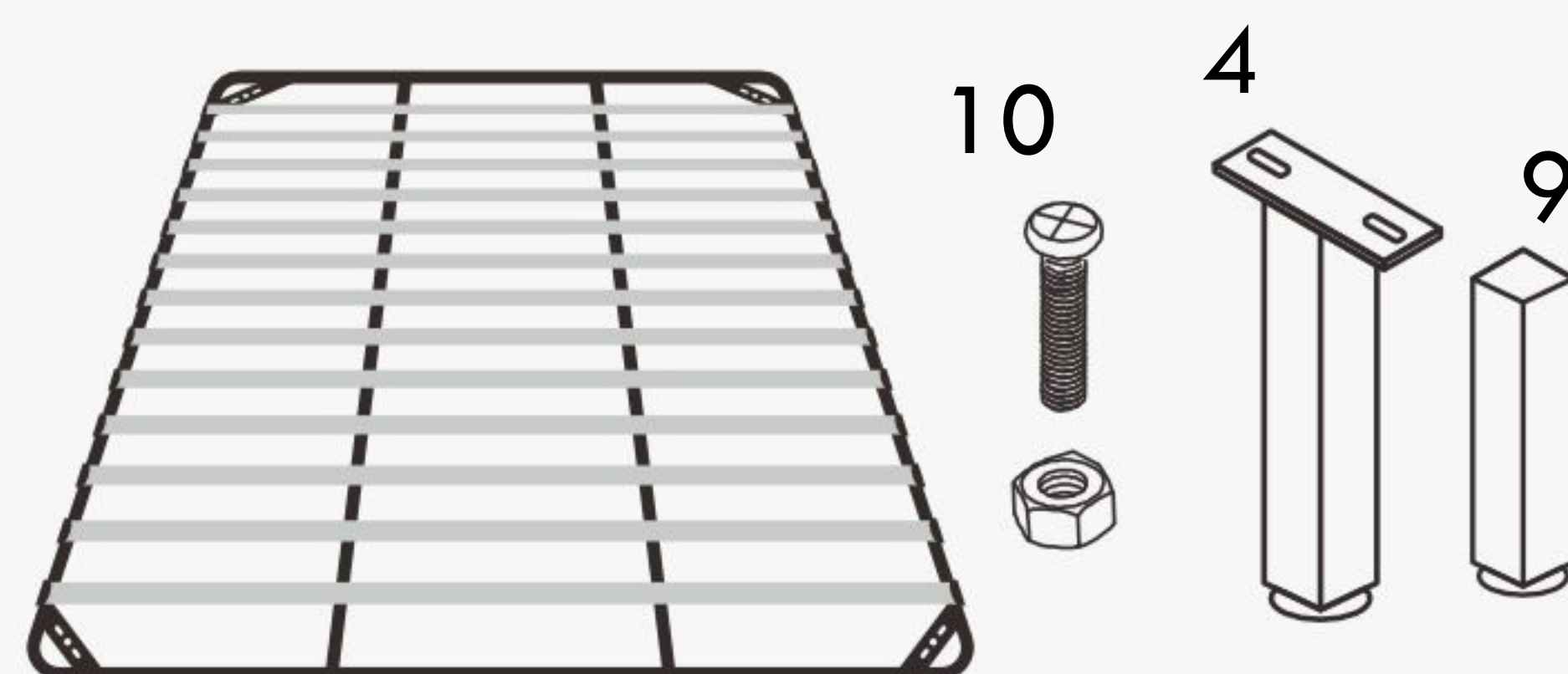

STEP 5

