









FLATBED ASSEMBLY INSTRUCTIONS

TWIN / SINGLE

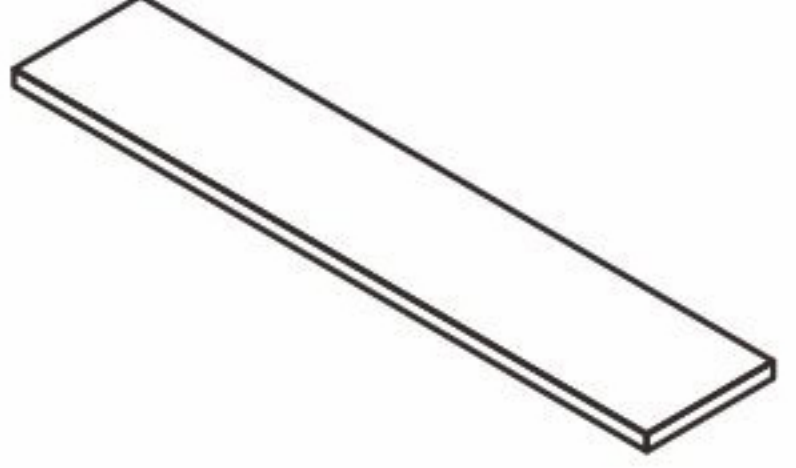
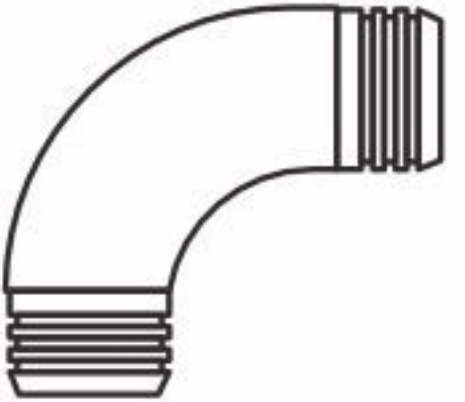
Hardware List:

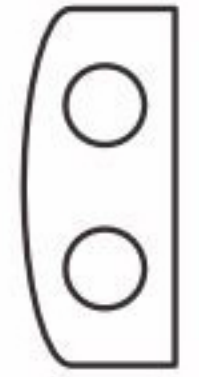
1  Short tube X2	2  Long tube X2	3  Central tube X1	4  Metal leg (T shape) X4	5  Wood slat X13
6  Plastic corner connector X4	7  Metal brackets X4	8  Single side plastic cap X26	9  Metal leg (I shape) X1	10  Screw +nut X 29

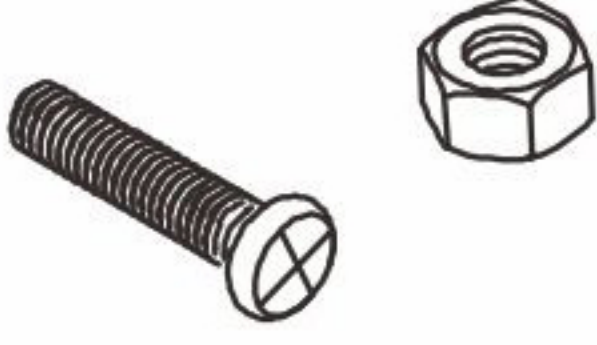
STEP 1

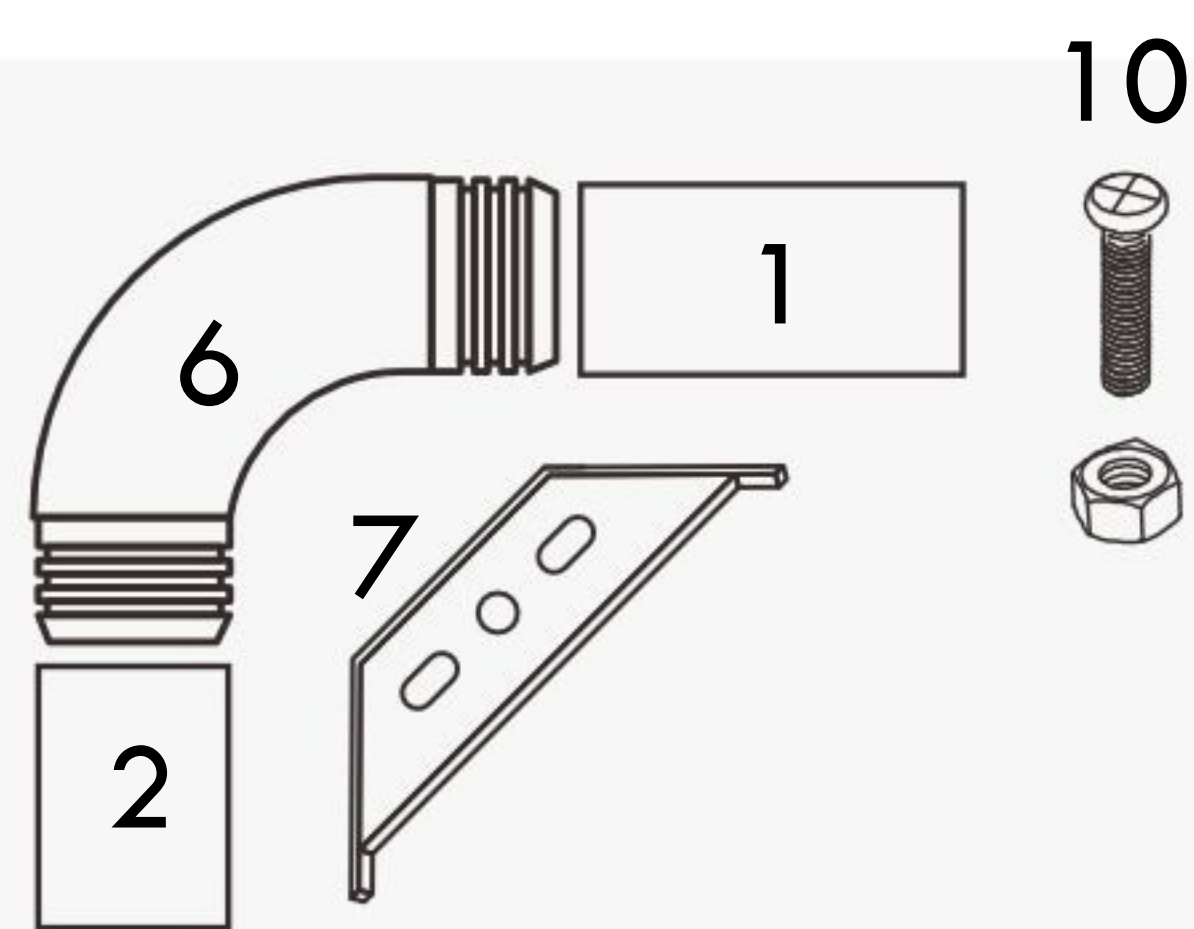

STEP 2

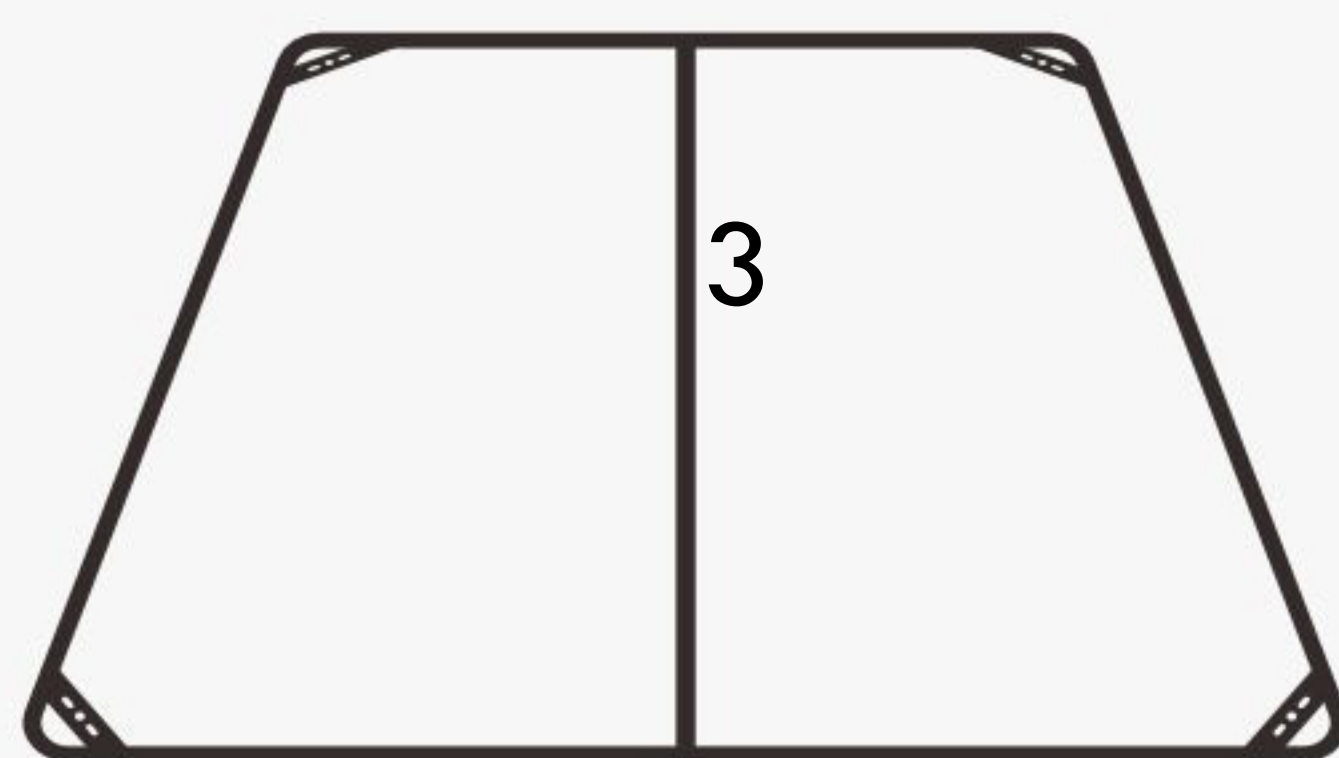

STEP 3

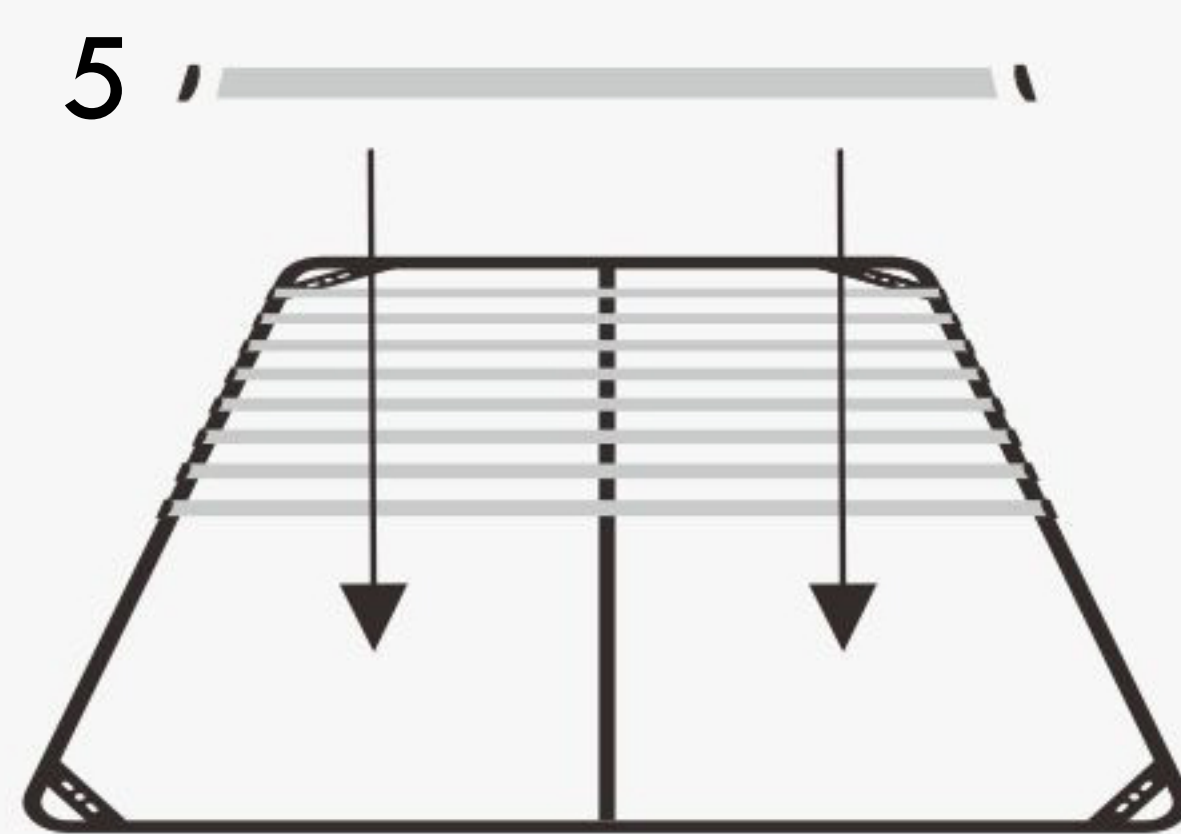

STEP 4

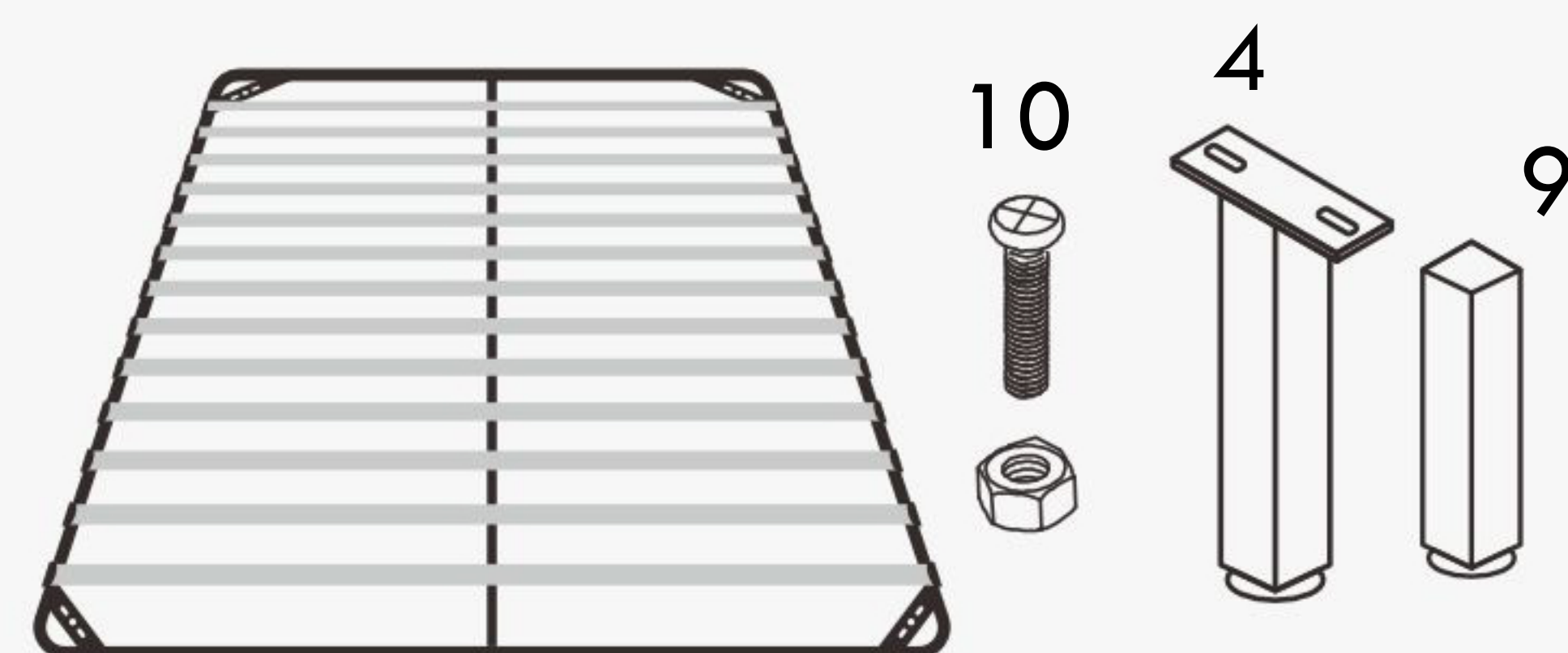

STEP 5

